



Preparation of ^{18}F -NaF radiopharmaceuticals using home-made automatic synthesis module at Hanoi Irradiation Center

Tran Manh Thang¹, Mai Van Vinh¹, Dam Thi Tam¹, Nguyen Quang Anh¹,
Le Thi Thu Hien¹, Pham Minh Duc¹, Nguyen Tuan Anh¹, Nguyen Van Sy¹,
Nguyen Thanh Hung¹, Dang Quang Bao¹, Nguyen Xuan Vinh¹, Nguyen Thi Kim Dung²

¹Hanoi Irradiation Center, Km12, Road 32, Minh Khai, Tu Liem North, Hanoi, Vietnam

²Nuclear Medicine Department, 108 Military Central Hospital,
No. 1, Tran Hung Dao, Hai Ba Trung, Hanoi, Vietnam
Email: tmthangbk@yahoo.com

Abstract: The aim of this study is to prepare ^{18}F -NaF radiopharmaceutical using a home-made automatic synthesis module consisting of hardware and software which was made by a researcher-team of Hanoi Irradiation Center, HIC, Hanoi, Vietnam. Fluorine-18 isotopes produced in cyclotron KOTRON13 were transferred to the module and radioactive cation impurities were first removed by cation exchange on a carboxymethyl cation exchange (CM) cartridge, and then $^{18}\text{F}^-$ ion were trapped by a quaternary methyl ammonium anion exchange (QMA) cartridge. Finally, $^{18}\text{F}^-$ was eluted from the cartridge by isotonic saline water (NaCl 0.9% in water) in the form of ^{18}F -NaF. Time of the preparation process was about 13 minutes. Radiochemical yield of the preparation was as high as 95.5%, in average. The qualities of the product were satisfied the criteria of the United States Pharmacopoeia (USP38). PET/CT bone scanner (skeletal scintigraphy) pre-clinical tests using of the ^{18}F -NaF product showed good quality of imaging for the entire skeletal and distribution of the ^{18}F -NaF in the kidney and the bladder agreed with its natural distribution.

Keywords: Sodium [^{18}F]-fluoride radiopharmaceutical, KOTRON13 cyclotron, Synthesis module, bone scan.

I. INTRODUCTION

The use of ^{18}F -NaF radiopharmaceuticals for bone scintigraphy dates back to the early 1960s [1]. It was introduced as a skeletal PET imaging agent by Blau in 1962 [2,3]. The indication of ^{18}F -NaF as a bone scintigraphy agent to define areas of altered osteogenic activity was approved by the U.S. Food and Drug Administration (FDA) in 1972 [2,4]. However, due to the unavailability of cyclotron to produce ^{18}F preparation in many countries at that time, that the bone scintigraphy has been conveniently performed with phosphate compounds labelled with technetium-99m.

The $^{99\text{m}}\text{Tc}$ obtained as a decay product from molybdenum-99 [5,6] produced on nuclear reactors. Therefore until 2000, FDA approved ^{18}F -NaF as a radiopharmaceuticals for bone scintigraphy as part of its modernization on the handling of new drug applications [1]. The demand of ^{18}F -NaF radiopharmaceutical is expected to increase rapidly in the coming years [5]. Nowadays, $^{99\text{m}}\text{Tc}$ -methylene diphosphate ($^{99\text{m}}\text{Tc}$ -MDP) and ^{18}F -NaF have been used in bone scintigraphy with SPECT (gamma camera) and PET/CT, respectively. However, comparing image using ^{18}F -NaF/PET-CT technique with those of using $^{99\text{m}}\text{Tc}$ -MDP/SPECT showed that the former technique has a higher sensitivity in detecting osteolytic lesions compared to the latter one.

The ^{18}F -NaF/PET-CT shows high sensitivity in both lytic and blastic lesions. Further, there are many advantages of using ^{18}F -NaF in imaging such as sensitivity, specificity, high spatial, contrast resolution compared to the $^{99\text{m}}\text{Tc}$ use in combination with CT or MRI surgery information [7]. In recent years, some of nuclear reactors around the world which regularly supply molybdenum-99 (technetium-99m generators) are going to shutdown [8]. This could be leading to a large number of patients would be denied essential imaging diagnosis and the nuclear medicine community would fall into crisis by the lack of $^{99\text{m}}\text{Tc}$ supply [5]. Moreover, fluorine-18 isotope that is produced by cyclotron has a short half-life (109.83 minutes) so it can not be imported from abroad. Up to present

(2019), Vietnam has seven cyclotrons (three in Hanoi City, one in Da Nang hospital, one is under installation in Kien Giang hospital, two in Ho Chi Minh City). Therefore, the development and application of ^{18}F -NaF radiopharmaceuticals are feasible. In the future, it can be replaced a part of $^{99\text{m}}\text{Tc}$ -MDP in the bone cancer diagnosis.

At present, many companies have commercialized ^{18}F -NaF radiopharmaceuticals synthesis module with the yield of over 90% such as Eckert & Ziegler [9], GE, IBA [1,10], TRASIS [11], KIRAMS, etc. Current process of preparation of ^{18}F -NaF radiopharmaceuticals worldwide is based on the same principle according to the flow chart shown below.

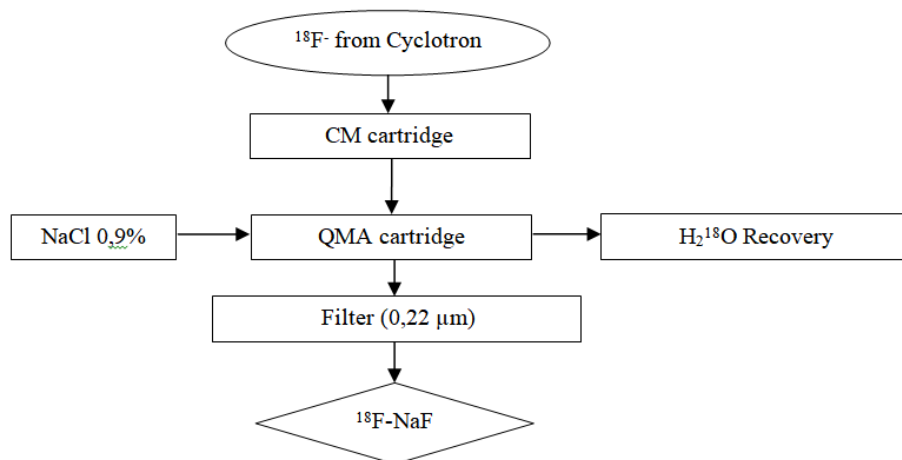

Fig. 1. Flow chart of ^{18}F -NaF radiopharmaceuticals preparation

In Fig. 1 CM and QMC stand for carboxymethyl cation ion exchange and quaternary methyl ammonium anion exchange

In this study, a procedure of ^{18}F -NaF radiopharmaceuticals preparation on a home-made automatic synthesis module is presented. The module was manufactured by a researcher-team of Hanoi Irradiation Center (HIC) which includes hardware and software to control operation of the module (Fig. 2). The process of preparation was evaluated for its chemical, radiochemical yields. The ^{18}F -NaF product

produced was checked for its quality and pre-clinical tests.

II. EXPERIMENT

A. Chemicals, materials and methods

- **Material for ^{18}F -NaF module manufacture**

The hardware of the module includes: two stepper motor moving up and down, six of 2/2 way valves type 0127 ID 120721 from Burkert-Germany, six of 3/2 way valves type 0127 ID 120433 from Burkert-Germany, two

radioactivity monitoring detectors, Teflon tube, PEEK and super flangeless fittings, flangeless fittings, flangeless fitting for 1/16" OD tubing, bulk head unions, Y connectors, and quick-connect Luer adapters from

Kinesis-UK, etc. The size of the module is 400(H) x 300(L) x 285(W) mm (Fig.2). Software for operational control of the module was written on Labview programming language.



Fig. 2. A view of the home-made automatic module used for preparation of ^{18}F -NaF

- ***Chemicals and materials for ^{18}F -NaF synthesis***

Enriched [^{18}O]-water (H_2^{18}O) was supplied from the Rotem/Israel (^{18}O purity > 97%). Quaternary methyl ammonium Sep-Pak Accell Plus Light (QMA) cartridges and carboxymethyl Sep-Pak Accell Plus Short (CM) Cartridges were purchased from the Waters (USA). Ethyl alcohol (PA grade), acetonitrile (PA grade), glass-based silica thin layer chromatography (TLC) plates, Millex-FG filters were from the Merck/Germany. AEF filters 0,22 μm pore size are from the PALL (UK); sterile water for injection and NaCl isotonic saline water (0,9 %) were from the Fresenius Kabi Bidiphar/Vietnam. Syringes of 20mL capacity were from the BD (Belgium). Venting needles were from the Millipore (USA) and sterile vacuum vials were from Korea.

- ***Materials and equipment for product's quality control***

pH of the preparation was measured using indicator strips (Macherey-Nagel); half-life of ^{18}F isotope was determined by a Dose calibrator (ISOMED2010-Germany); Chemical purity of ^{18}F -NaF preparation was analyzed by Radio-TLC development following by scanning using a Raytest scanner from Germany and Radio-HPLC Agilent 1260-Raytest; radionuclide purity of ^{18}F -NaF preparation was identified by using multi-channel analyzer (MCA/Raytest-Germany); Residual solvent (ethyl alcohol) was determined by Gas chromatography (GC/Agilent 7890B); Bacterial Endotoxins was tested by Endotoxin PTS-100 (Charles River, USA); Sterility was examined in the Dalat Nuclear Research Institute's laboratory.

Quality of ^{18}F -NaF radiopharmaceuticals was evaluated at the HIC, Cyclotron Center of the 108 Military Central Hospital, and Dalat Nuclear Research Institute laboratories.

PREPARATION OF ^{18}F -NAF RADIOPHARMACEUTICALS USING HOME-MADE AUTOMATIC...

Ossein scintigraphy was performed with the use of ^{18}F -NaF at a PET/CT Light Speed device (GE, USA) at Nuclear Medicine Department, 108 Military Central Hospital.

Preparation of QMA, CM cartridges before its use

Sep-park QMA and CM cartridges need to be activated before its use. First, both of them were preconditioned with 10 mL ethyl alcohol then, they were washed by 12 mL sterile water for injection. Finally, they were dried by blowing a dry air flow.

Production of ^{18}F -NaF radiopharmaceutical

Fluorine-18 was produced by bombardment of protons particles accelerated to energy 13 MeV on a KOTRON13 cyclotron (Korea) located in the HIC. The reaction was proceeded as follows.



5 mL of enriched ^{18}O -water as a liquid target was circulated through a Nb cavity covered with Havar foil window. The target was bombarded with proton beam of a current of 30 μA for 60 minutes. Resulting solution containing H^{18}F was transferred into the automatic synthesis module (Fig.2, 3). The H^{18}F solution first was allowed to pass through the CM cation exchange cartridge that was prepared previously to purify all cations impurities generated from activation reactions between protons and the metals made of the Havar alloy, then the solution was passed through QMA cartridge where ^{18}F anions were trapped on the resin. Finally, ^{18}F was eluted from the QMA cartridge with 10 mL of 0,9% NaCl isotonic saline solution. The solution of ^{18}F -NaF was filtered through an AEF filter of 0.22 μm pore size into a sterile, pyrogen-free vial. Progress of the synthetic processes will be shown on screen by an animation scheme (Fig. 3).

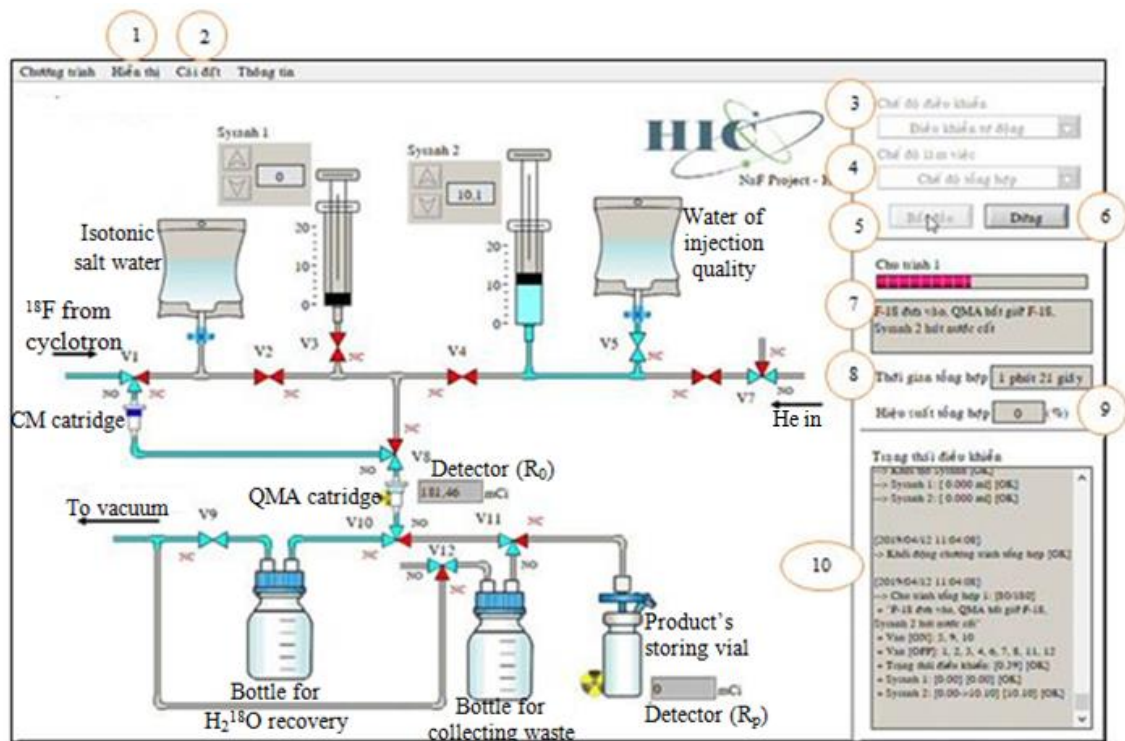

Fig. 3. Graphical screen showing progress of ^{18}F -NaF preparation process

Operation of the module was programmed with following menu:

Section	Image	Operation
1	Display	Value of measured radioactivity will be displayed as graphs
2	Set-up	This menu is for input of necessary data
3	Control mode	This menu is used for automatic control or manual control
4	Process mode	This menu is used for synthesis or cleaning equipment
5	Start	Start a process under the conditions which were input
6	Stop	Stop a process
7	Program running	Show current status of the module
8	Elapsed time	Display elapsed time since the moment of program started
9	The Yield	Display the yield of a synthetic batch
10	Control status	Display status of process

IV. RESULTS AND DISCUSSIONS

$$Y = \frac{R_p}{R_o} \times 100 \% \quad (2)$$

Ten (10) batches of ¹⁸F-NaF were prepared for evaluating performance of the module, and for determining the quality of the product and for pre-clinical test with PET/CT technique.

The yield of synthetic process

The yield of synthetic process was estimated by the formula:

Where R_p is the final product activity measured in position of the product storing vial (Fig.3); R_o is the initial activity measured in position of the QMA cartridge (Fig. 3).

The yield of ¹⁸F-NaF preparation achieved in average around 95.5% in 10 experimental batches as shown in Fig. 4. The time of the synthetic process is about 13 minutes.

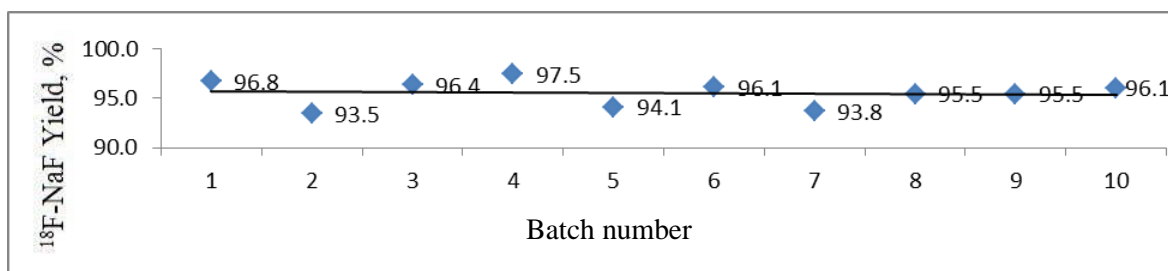

Fig. 4. The yield of ¹⁸F-NaF synthetic process determined by batch

Quality of the product

The quality of the product was examined. Result of the examination showed that ¹⁸F-NaF solution was clear, colorless,

contains no particulate matters. Other parameters were also satisfied the criteria of the United States Pharmacopoeia (USP38) applied to ¹⁸F-NaF pharmaceuticals as shown in Table I [12].

Table I. Quality of ^{18}F -NaF produced at HIC, Hanoi, Vietnam

Parameter	Release Criteria (USP38)	Result
Appearance	Clear, colorless, no contains particulate matters	Pass
pH	4.5 - 8.0	7.0
Radiochemical purity	> 95%	> 95%
Radionuclidic purity	> 99,5 % (511±15 keV)	Pass
Half-life	105-115 min	Pass
Residual solvent	< 5 mg/mL	Pass
Endotoxin	< 175 EU/mL	Pass
Sterility	Sterile	Pass

pH value of the solution was around 7.0 that met the acceptance criteria of between 4.5 to 8.0. Radiochemical purity of the product was higher than 95 % of the total radioactivity measured as it was

determined by TLC development. The retention factor (R_f) of the product was found to be from 0.0 to 0.01 (Fig.5). The acceptance criteria for radiochemical purity is not less than 95%.

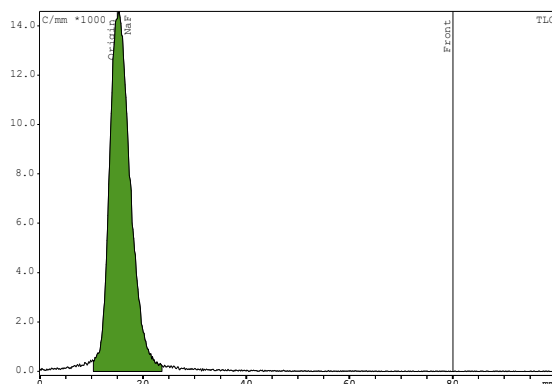

Fig. 5. The radio-TLC spectrum of ^{18}F -NaF produced at the HIC

Radiochemical purity and identity of ^{18}F -NaF product were higher than 95 % of the total radioactivity measured at retention time around 4.5 minutes (Fig.6).

Radionuclidic purity was checked using a multi-channel gamma spectrometer and it was found that the purity of the product is not less than 99.5 % at 511 keV peak (Fig.7) that met the acceptance criteria of not less than 99.5%.

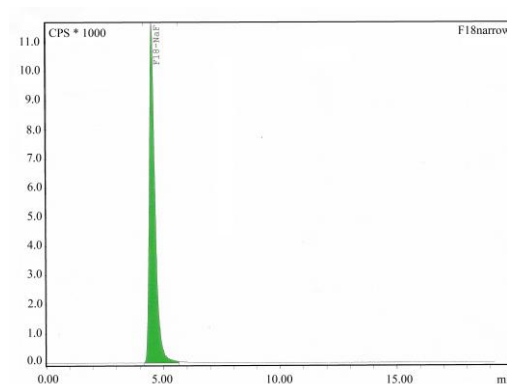

Fig.6. The radio-HPLC spectrum of ^{18}F -NaF produced at the HIC

Bacterial Endotoxin was not more than 175 EU/mL (USP Endotoxin Units per mL) of injection that met the acceptance criteria of not more than 175 EU/mL. The test for sterility is carried out under aseptic conditions. Sterility was tested in the fluid thioglycolate medium at 30-35°C, the soya-bean casein medium and incubated at 20-25°C, respectively. The samples were counted 14 days after incubation. The produce was sterile that met the acceptance criteria of sterile.

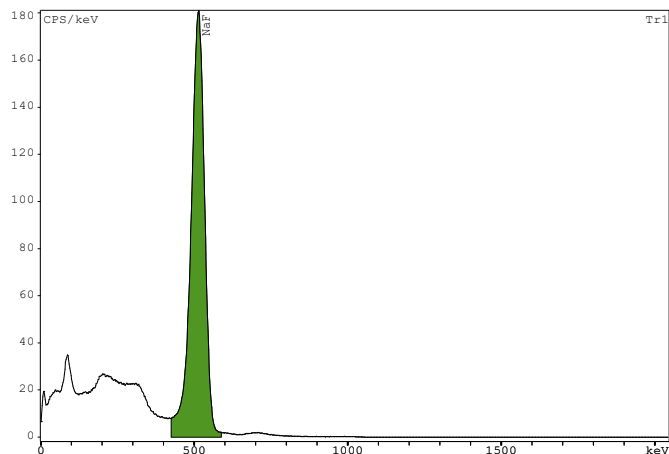

Fig.7. A gamma spectrum of ^{18}F -NaF showing a peak at 511 keV

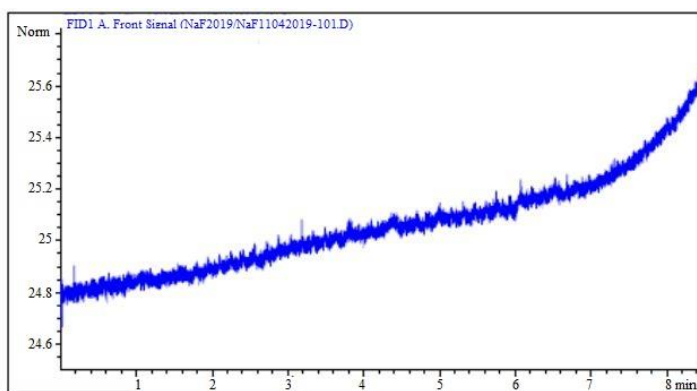

Fig.8. A GC chromatogram of solution ^{18}F -NaF produced at the HIC showing no peak representing ethyl alcohol

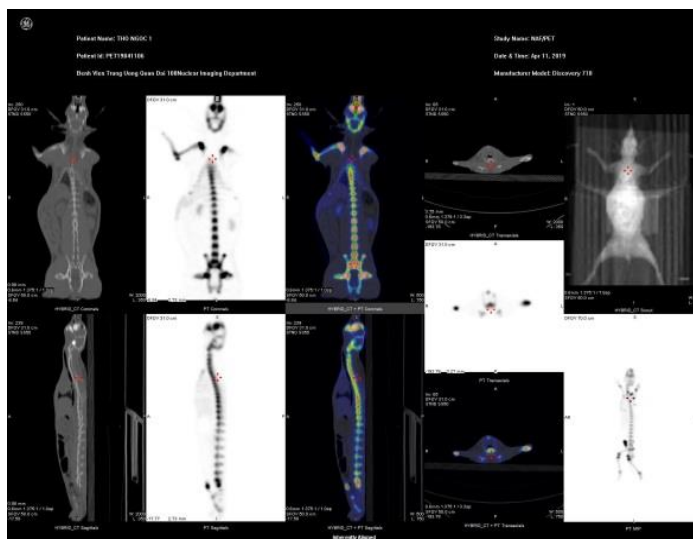

Fig. 9. PET/CT images of rabbits administered with ^{18}F -NaF preparation produced at the HIC Imaging Study and biodistribution

Pre-clinical study is carried out at Nuclear Medicine Department, 108 Military Central Hospital in Hanoi. Subject of the test were rabbits to which were injected about 0.3-0.4 mCi (about 0.14 mCi/kg) of ^{18}F -NaF solution. The uptake time for animals was 40 minutes. Afterwards, animals were scanned with a low-dose CT, full body PET scanner. PET attenuation images were corrected by CT. Standardized uptake values (SUV) are the maximum values at the region of interest and calculated in g/mL.

Images of ^{18}F -NaF showed that metabolism of the radiopharmaceuticals spread throughout the entire skeletal of the animal: in the skull bone, ribs bones, spine bones, upper extremities, two lower limbs, and pelvis. Distribution of ^{18}F -NaF product in kidney and bladder shows it's natural distribution.

III. CONCLUSIONS

In this study, it was proven that the Hanoi Irradiation Center has successfully manufactured automatic synthesis module for ^{18}F -NaF radiopharmaceuticals. The duration of the synthetic process was about 13 mins. Radiochemical yield was as high as 95.5%, in average. Quality of the product satisfies the criteria of the United States Pharmacopoeia (USP38). The PET/CT imaging test on animals showed good quality for entire skeletal, kidney and bladder.

ACKNOWLEDGMENTS

The financial support to conduct this research was from Ministry of Science and Technology of Vietnam under Project encoded ĐTCB.07/16/TTCX. The authors are thankful to Vietnam Atomic Energy Institute, and Hanoi Irradiation Center for the administrative assistances. The co-operation of 108 Military Central Hospital and Dalat Nuclear Research

Institute is acknowledged. The authors would like to thank Dr. Jung Young Kim, Korea Institute of Radiological & Medical Sciences for his valuable discussions during the study.

REFERENCE

- [1]. Natalia M. Leonardi, Guillermo A. Casale, Jorge Nicolini, Patricia D. Zubata, and Maria J. Salgueiro. Validation of a paper chromatographic methodology as an alternative for determination of the radiochemical purity of Na^{18}F , *Nucl. Med. Technol.*, 40: 271-274, 2012.
- [2]. Yuan H., Merrill J. R., Parrott M. and Anzellotti A. [^{18}F]NaF Manufacture via the ABT BG75 system. Imaging and Biodistribution studies." University of North Carolina at Chapel Hill, NC27599, School of Medicine, pp.1-6.
- [3]. Mark S. Jacobson, Raymond A. Steichen, and Patrick J. Peller. PET radiochemistry and radiopharmacy", *Springer-Verlag Berlin Heidelberg*, 703: 19-30, 2012.
- [4]. Rajeev Kumar, Rajendra G. Sonkawade, Madhavi Tripathi, Punit Sharma, Priyanka Gupta, Praveen Kumar, Anil K. Pandey, Chandrasekhar Bal, Nishikant Avinash Damle, and Gurupad Bandopadhyaya. Production of the PET bone agent ^{18}F -fluoride ion, simultaneously with ^{18}F -FDG by single run of the medical cyclotron with minimal radiation exposure - A novel technique, *Hell J. Nucl. Med.*, 17: 106-110, 2014.
- [5]. Brian G. Hockley and Peterj H. Scott. An automated method for preparation of [^{18}F] sodium fluoride for injection, USP to address the technetium-99m isotope shortage. *Appl. Radiat. Isot.*, 68: 117-119, 2010.
- [6]. Jae Yong Choi, Ji Woong Lee, Kyo Chul Lee, Kyeong Min Kim, Young beom Seo, Jung Young Kim, Young Hoon Ryu. Time and cost effective production of sodium [^{18}F]fluoride using a dedicated automation module with disposable cassettes for GMP

- environment. *J. Radioanal. Nucl. Chem.*, 309: 938-987, 2016.
- [7]. Frederick D. Grant, Frederic H. Fahey, Alan B. Packard, Royal T. Davis, Abass Alavi, and S. Ted Treves. Skeletal PET with ^{18}F -Fluoride: Applying new technology to an old tracer. *The J. of Nucl. Med.*, 49(1): 68-78, 2008.
- [8]. Nuclear and Radiation Studies Board Division on Earth and Life Studies. Opportunities and approaches for supplying molybdenum-99 and associated medical isotopes to Global Markets. In Proc of a Sym. Washington, DC. *The National Academies Press*. Chapter 3: Current molybdenum-99 supply, pp. 13-17, 2018.
- [9]. Modular-Lab PharmTracer, Cassette-based routine production of ^{18}F tracers, Eckert & Ziegler, <https://radiopharma.com/wp-content/uploads/2018/01/7131-0077.pdf> (7131-0077/Rev.04/05. 2019). Accessed on 19 November 2019.
- [10]. Bernard Lambert, Jean-Jacques Cavelier, Guillaume Gauron, Christophe Sauvage, Cécile Kech, Tim Neal, M. Kiselev, David Caron, Anat Shirvan, Ilan Ziv. Routine automated production of ^{18}F -labelled radiopharmaceuticals on IBA Synthera@ Multi-Purpose Platform. Presented at the 13th WTTTC 2010 in RISOE/Denmark., Abstract No.016, 2010.
- [11]. Charlotte Collet, Muhammad Otabashi, Fabrice Giacomelli, Nicolas Veran, Gilles Karcher, Yves Chapleur, Sandrine Lamandé-Langle. Fully automated production of sodium [^{18}F]fluoride on All In One and mini All In One synthesizers. *Appl. Radiat. and Isot.*, 102: 87-92, 2015.
- [12]. The United States Pharmacopeial Convention, "Sodium Fluoride F-18 Injection", *USP38*, pp. 3546-3547, 2015.